



Distributed Design Series™

Surface Mount Loudspeakers

Installation and Operation Manual



<u>Model</u>	<u>Driver Diameter</u>	<u>Description</u>
DS5	5.0" 127 mm	full-range
DS8	8.0" 203.2 mm	full-range
DS8SUB	8.0" 203.2 mm	subwoofer

Introduction & Product Description

Thank you for your choice of Community's *Distributed Design Series™ Surface Mount Loudspeakers*. This series is comprised of the following models:

Model	Description
DS5	5" 2-way surface-mount*
DS8	8" 2-way surface-mount*
DS8SUB	8" subwoofer surface-mount*

**All models are available in black or white.*

The *Surface Mount Series* have a unique, modern-looking streamlined architectural design. Their black or white cabinets are easy to customize since they accept a wide variety of paints. For durability and improved sonic quality, the cabinets have thick-wall, internally-reinforced ABS plastic construction. This high-impact strength construction reduces resonances, and the rounded surfaces further reduce the resonances that occur in flat-sided cabinets.

Each model is shipped as a matched pair of completely assembled loudspeakers, including everything needed for standard installations. The DS5 and DS8 are full-range models, each with high and low frequency drivers and built-in crossover networks. The DS8SUB subwoofer includes a built-in low pass filter and can be used in conjunction with either of the full-range models in applications benefitting from extended low frequency enhancement.

You can use 8-ohm or constant voltage distribution with the built-in 70/100 volt autoformer. Power is easy to adjust using a front-accessible power tap switch.

We urge you to read these instructions carefully and familiarize yourself with the features and installation methods before you begin the job. If you have any questions or concerns, please contact Community.

Table of Contents

Introduction & Product Description	2
Packing List & Feature Identification	3
Important Safety Instructions	4
Infin-A-Ball™ Mounting System	6
Installation & Wiring	7
Optional Wall Box Mounting	10
Painting the Loudspeaker	10
Specifications	11
Warranty and Servicing Notes	11

Copyright © 2013 by

Community Professional Loudspeakers, Chester, Pennsylvania, USA. All Rights Reserved.

Packing List and Feature Identification

Community *Distributed Design Series Surface Mount Loudspeakers* are engineered and manufactured to be rugged and they are carefully packed in sturdy cartons. However, it is wise to thoroughly inspect each unit after it has been removed from the packaging, as damage could occur during shipping.

Please note that once the shipment has left your dealer or the Community factory, the responsibility for damage is always borne by the freight company. If damage has occurred during shipping, you must file a claim directly with the freight company. It's very important to contact the freight company as soon as possible after receiving your shipment, as most freight companies have a short time limit within

which they will investigate claims. Make sure to save the carton and the packing material, as most claims will be denied if these materials are not retained.

Although we illustrate a single loudspeaker below to show the included parts, in fact these loudspeakers are shipped in pairs. For a given model, this is what's included:

- Surface Mount Loudspeaker Cabinets (Qty 2)
- Grille Assembly (Qty 2)
- Infin-A-Ball Mounting Brackets (Qty 2)
- Hex Wrench (Qty 1)
- Small Flat screwdriver (Qty 1)

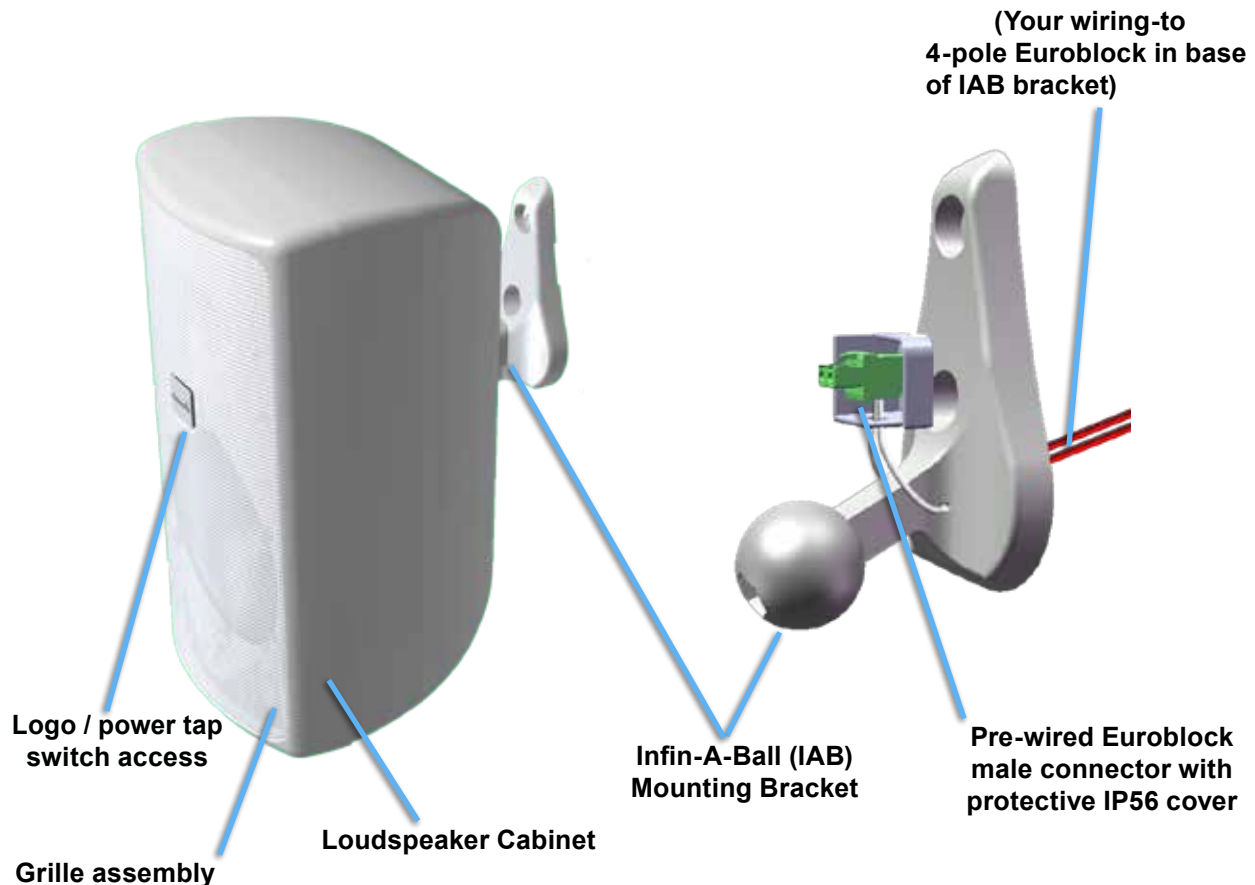

Important Safety Instructions

Always follow these basic safety precautions when using or installing *Distributed Design Series Surface Mount Loudspeakers* and accessories:

- Read these instructions.
- Keep these instructions.
- Heed all warnings.
- Follow all instructions, particularly those pertaining to rigging, mounting, hanging and electrical connections.
- Do not use this apparatus near water.
- Clean only with dry cloth.
- Do not block any ventilation openings. Install in accordance with the manufacturer's instruction.
- Do not install near any heat sources such as radiators, heat registers, stoves, or other apparatus (including amplifiers) that produce heat.
- Only use attachments/accessories that are specified and approved by the manufacturer.
- Refer all servicing to qualified service personnel. Servicing is required when the apparatus has been damaged in any way, such as power-supply cord or plug is damaged, liquid has been spilled or objects have fallen into the apparatus, the apparatus has been exposed to rain or moisture, does not operate normally, or has been dropped.

The terms caution, warning, and danger may be used in this manual to alert the reader to important safety considerations. If you have any questions or do not understand the meaning of these terms, do not proceed with installation. Contact your local dealer, distributor, or call Community directly for assistance. These terms are defined below:

CAUTION: describes an operating condition or user action that may expose the equipment or user to potential damage or danger.

WARNING: describes an operating condition or user action that will likely cause damage to the equipment or injury to the user or to others in the vicinity.

DANGER: describes an operating condition or user action that will immediately damage the equipment and/or be extremely dangerous or life threatening to the user or to others in the vicinity.



WARNING: To reduce the risk of fire or electric shock, do not expose this apparatus to rain or moisture.

These servicing instructions are for use by qualified service personnel only. To reduce the risk of fire or electric shock do not perform any servicing other than that contained in the operating instructions unless you are qualified to do so.

The loudspeakers described in this manual are designed to be 'flown' or suspended for maximum acoustical performance using a variety of rigging hardware, means, and methods in some applications. It is essential that all installation work involving the suspension of these loudspeaker products be performed by competent, knowledgeable persons who understand safe rigging practices. Severe injury and/or loss of life may occur if these products are improperly installed. Please read the section on *Installation and Wiring* for additional information.

L'information de Sûreté Importante

PRÉCAUTION: Veuillez toujours suivre ces mesures de sécurité de base lors de l'utilisation ou lors de l'installation des haut-parleurs *Distributed Design Series Surface Mount* et de ces accessoires :

- Lisez et Gardez les instructions.
- Observez tous les avertissements.
- Suivez toutes les instructions, particulièrement ceux concernant le calage, support, montage et raccordements électriques.
- Ne pas utiliser cet appareil près de l'eau.
- Nettoyez seulement avec un tissu sec.
- Ne pas bloquer les ouvertures de ventilation. Installer conformément aux instructions du fabricant.
- Ne pas installer près des sources de chaleur comme les radiateurs, les cuisinières, foyers ou autres appareils (y compris les amplificateurs) qui peuvent produire de la chaleur.
- Utilisez seulement les accessoires qui sont spécifiés et approuvés par le fabricant.
- Référez tout entretien au personnel qualifié de service. Ceci est exigé quand l'appareil a été endommagé de quelque façon, incluant le fil d'alimentation et ou l'embout du fil a été endommagé, des liquides ont été renversés ou des objets sont tombés à l'intérieur de l'appareil, l'appareil a été exposé à la pluie ou l'humidité, l'appareil ne fonctionne pas normalement ou a été échappé.

Les termes attention, avertissement, et danger peut être utilisés dans ce manuel pour alerter le lecteur aux considérations importantes de sûreté. Si vous avez des questions ou ne comprenez pas la signification de ces termes, ne procédez pas à l'installation. Contactez votre détaillant, distributeur, ou Community directement pour assistance. Les termes sont définies ci-dessous:

ATTENTION: décrit une condition de fonctionnement ou une action d'utilisateur qui peuvent exposer l'équipement ou l'utilisateur aux dommages potentiels ou au danger.

AVERTISSEMENT: décrit une condition de fonctionnement ou une action d'utilisateur qui peuvent causer des dommages probable à l'équipement et/ou à l'utilisateur et à ceux se trouvant à proximité.

DANGER: décrit une condition de fonctionnement ou une action d'utilisateur qui endommageront immédiatement l'équipement et/ou seront extrêmement dangereuses et qui peut représenter un danger pour la vie à l'utilisateur et à ceux se trouvant à proximité.



AVERTISSEMENT: Pour réduire le risque de feu ou de décharge électrique, ne pas exposer cet appareil à la pluie ou l'humidité.

Ces instructions d'entretien sont pour l'usage d'un personnel de service qualifié seulement. Pour réduire le risque de feu ou de décharge électrique n'exécutez aucun entretien autrement que ce qui est contenu dans les instructions d'opérations à moins que vous êtes qualifié pour le faire.

Les haut-parleurs décrits en ce manuel sont conçus pour être accroché ou suspendus afin d'atteindre une exécution acoustique maximum en utilisant une série de différents matériaux, moyens, et méthodes de calage dans certaines applications. Il est essentiel que tout le travail d'installation impliquant la suspension de ces produits de haut-parleur soit effectué de façon sécuritaire par des personnes compétentes et bien formées dans les méthodes de calage. Des blessures graves et/ou des pertes humaines peuvent se produire si ces produits sont incorrectement installés. Veuillez lire la section sur le câblage et l'installation pour des informations supplémentaires.

Infin-A-Ball™ Mounting System

Community's *Infin-A-Ball™* (IAB) mounting system allows low-profile mounting and precise aiming over a broad tilt-swivel range. The IAB ball-mount receptacle is factory pre-attached to a recess in the cabinet, and after placing the loudspeaker onto the IAB bracket, you need only to twist the included hex wrench to lock any position. The IAB bracket has factory-installed internal wiring with an internal 4-pole Euroblock connector in its base (for neat loop-through connections) and a 2-pole male Euroblock plug near the ball end for connection to the cabinet. An IP56 wiring cover is also pre-installed, providing snap-on weather-resistant protection.

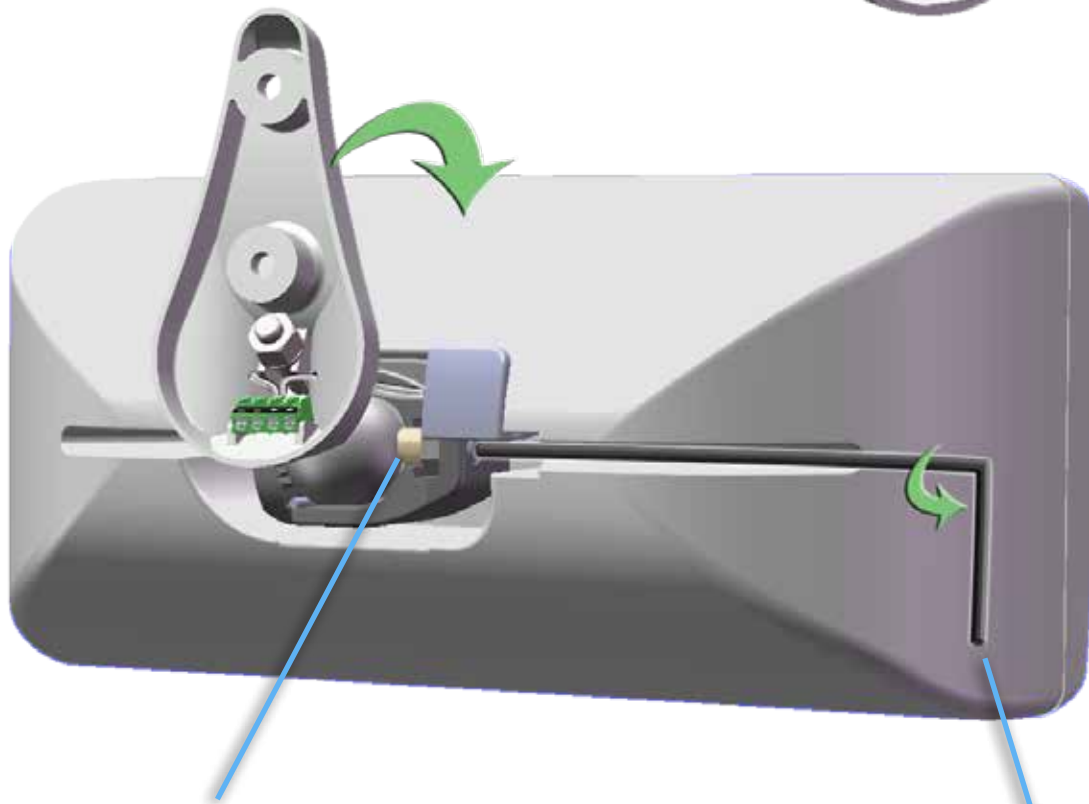
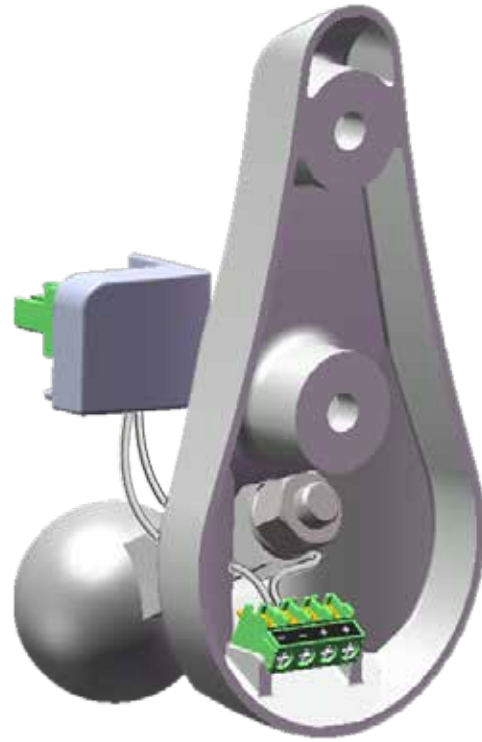

Actual clamping screw pressed against ball end of IAB bracket.

Loosen clamp using provided hex wrench, rotate loudspeaker cabinet to desired position, then tighten clamp to lock

Installation and Wiring

1. Connect incoming input wires (and optional loop-thru wires) from wall to 4-pole Euroblock screw terminals concealed in the base of the *Infin-A-Ball* bracket.*

***Note:** Check local codes to determine if a wall box or metal plate is required for the integrated wiring. See page 10.

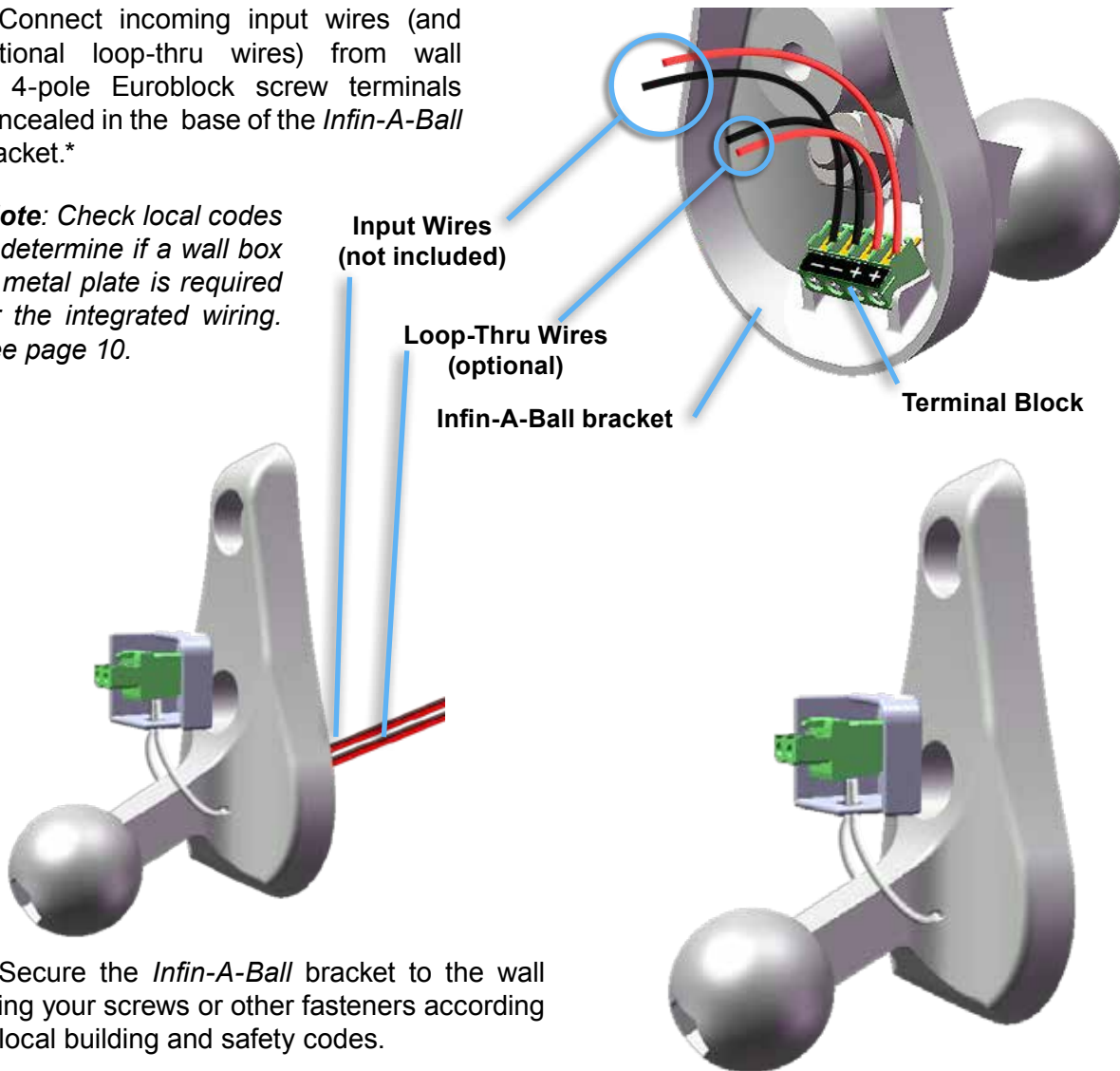

2. Secure the *Infin-A-Ball* bracket to the wall using your screws or other fasteners according to local building and safety codes.

3. Insert the hex wrench into the socket near the rear of the loudspeaker cabinet, and turn counterclockwise to loosen the clamp setscrew.

4. Fit the cabinet onto the IAB bracket's ball-end, then tighten the clamp sufficiently to hold the loudspeaker in place, but allowing for positional adjustment.

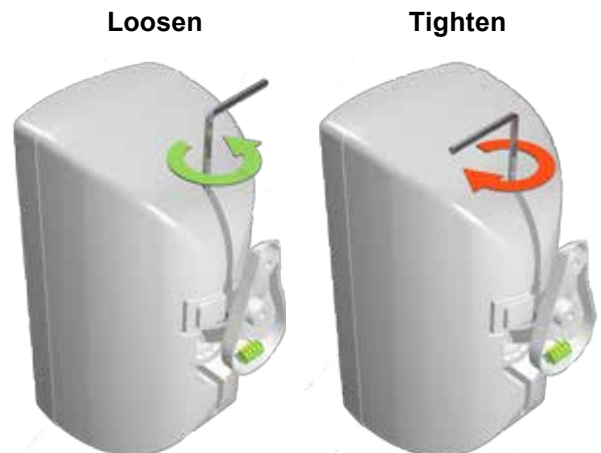

Vertical mounting



5. Adjust the cabinet position by rotating and tilting as desired. Then firmly tighten the locking screw with the provided hex wrench.

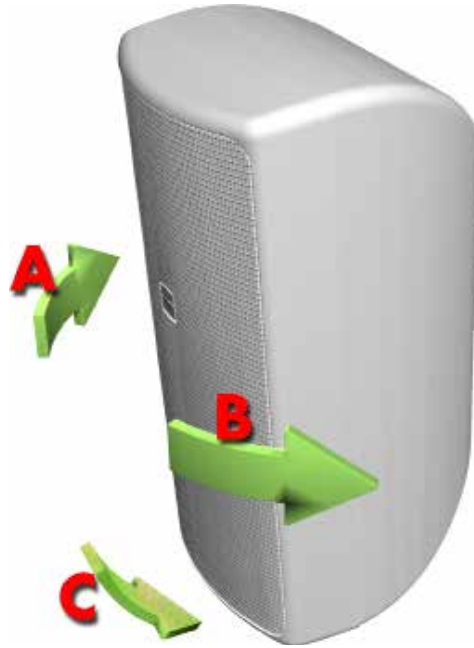

Horizontal mounting



6. Using a small slot-blade screwdriver (like the one provided) you can pry the logo plate out a few millimeters, then rotate it 90° and press it back in place so it reads correctly for horizontal or vertical mounting.

7. Once you have connected the wiring (next page), you can also remove the logo plate for access to the recessed tap-adjustment screw which you can use to set the power level for the individual loudspeaker as shown below.

Horizontal Mount Maximum Aiming Angle		
	DS5	DS8
A	8°	8°
B	20°	11°
C	64°	59°

Vertical Mount Maximum Aiming Angle		
	DS5	DS8
A	39°	39°
B	39°	39°
C	31°	33°

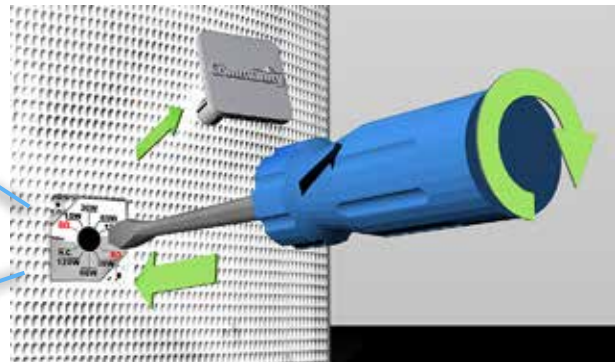
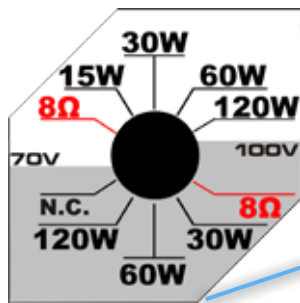

Note: This enlarged label shows the 70-volt/100-volt and 8-ohm power tap settings for the DS8. With 100-volt distribution, do not use the N.C. setting.



Note: The tap switch can only be adjusted using a flat-blade screwdriver such as the one provided with the loudspeaker.

8. Insert the 2-pole male Euroblock connector that is pre-wired to the *Infin-A-Ball* bracket into the mating female connector on the back of the loudspeaker cabinet.

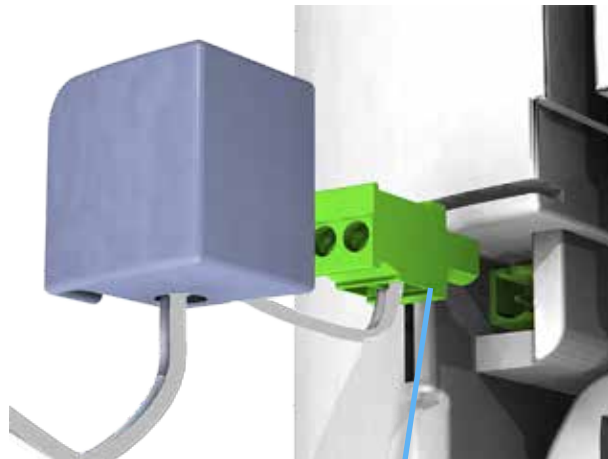

Male Euroblock

9. Then press the IP56 protective cover into place to weather seal the connection. No tool is needed for the cover; just snap it in place.

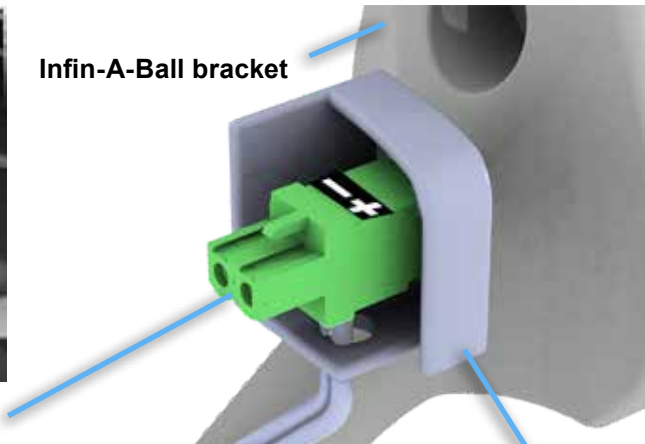

Infin-A-Ball bracket

IP56 Cover

10. A safety cable attachment loop is built into the rear of the loudspeaker cabinet as shown here. You can use this to attach a suitable safety cable as may be required by local building and safety codes or in accordance with best installation practices.

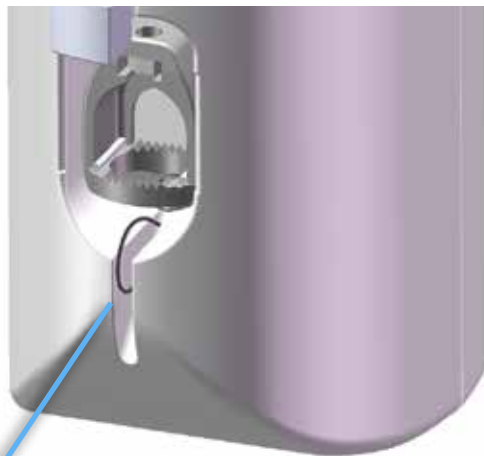

Safety cable attachment loop



Note: All electrical and mechanical installation connections for loudspeaker lines are subject to all applicable governmental building and fire codes. The selection of appropriate electrical and mounting hardware to interface with Distributed Design Series Surface Mount Loudspeakers lies solely with the installation professional. Community recommends that an appropriately licensed engineer, electrician, or other professional identify and select the appropriate conduit, fittings, wire, etc. for the installation.

Wall Box Mounting (optional)

While Community does not require or include a wall box or mounting plate with the loudspeakers, local building and safety codes may specify these items. If necessary, you can mount the IAB bracket approximately as shown here. The DS-WMP wall mount plate shown may be ordered as an option from Community. Use appropriate mounting hardware and fasteners, and secure per the steps below, making sure the installation is in accordance with the applicable codes.

1. Pull the wires through the cutout in the wall plate.
2. Attach the wall plate to the box using the provided screws.
3. Secure the wires to the connector in the base of the IAB bracket.
4. Attach the IAB bracket to the wall using an appropriate mounting method.*

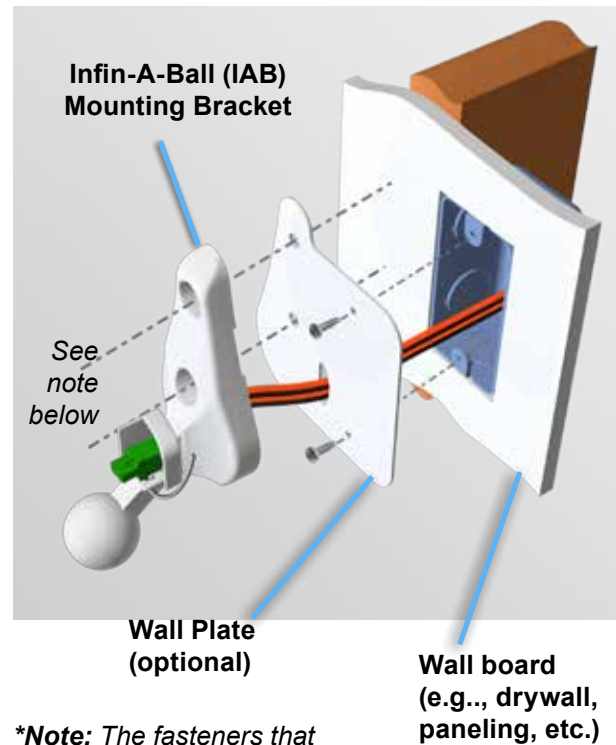

**Note: The fasteners that secure the IAB bracket are to be specified and provided by the installer.*

Painting the Loudspeaker

Type of Paint

These loudspeakers' ABS plastic cabinets accept almost any type of latex or enamel (oil based) paint. We recommend application of two coats. Note however that painting the grille requires spray painting.

Painting Process

Follow this procedure to obtain the best results:

1. Remove the grille.
2. Clean the grille assembly and the loudspeaker cabinet by rubbing them with a lightly dampened cloth. **Do not** use abrasives such as sandpaper or steel wool.



Caution: NEVER use abrasives, gasoline, kerosene, acetone, methyl ethyl ketone (MEK), paint thinner, harsh detergents or other chemicals. These chemicals and agents may permanently damage the finish. Some are also toxic and highly flammable.

3. Mask the loudspeakers so that the surrounds, cones and center areas will not receive any paint. We advise against using conventional masking tape and NEVER use duct tape in this application; these kinds of tape generally leave adhesive residue that can be difficult to remove and that may actually cause damage. Painters tape is best.

4. After cleaning, apply two or more thin coats of either latex or oil-based paints. Latex paint will adhere better if an oil-based primer is used first. Apply the paint with a roller or brush, or spray it on, except as noted below.

5. Use ONLY spray paint on the grille assembly; using a roller or brush to paint the grille is apt to cause its metal perforated holes to become clogged with paint. The grille should be painted separately, when it is **not** in place on the loudspeaker.

Specifications

Model	DS5	DS8	DS8SUB
Loudspeaker Type	Full Range Coax	Full Range Coax	Subwoofer
Description	5.0" Standard	8.0" Standard	8.0" Subwoofer
Operating Range (± 10 dB)	65 Hz - 22 kHz	60 Hz - 22 kHz	42 Hz - 200 Hz
Max Input Power Rating Continuous/Program	100W / 250W	150W/375W	2 0 0 W / 5 0 0 W
Sensitivity (1 W/1 meter)	93 dB SPL	95 dB SPL	88 dB SPL
Available 70 V Taps (watts)	60-30-15-7.5	120-60-30-15	2 0 0 - 1 0 0 - 5 0 - 2 5
Available 100 V Taps (watts)	60-30-15	120-60-30	200-100-50
Nominal Impedance	8 ohms	8 ohms	8 ohms
Enclosure Finish	Matte finish ABS, available in white or black		
Input Connections	4-pole Euroblock connector for two pair of 2-wire leads, uninterrupted whether loudspeaker is connected or not. Concealed IAB wiring to snap-seal connection on cabinet. 2-pole Euroblock connector for connection directly to enclosure.		
Dimensions: (Excluding IAB bracket)	H 12.9" (328 mm) W 6.3" (160 mm) D 7.5" (191 mm)	18.5" (470 mm) 9" (230 mm) 10.1" (257 mm)	18.5" (470 mm) 9" (230 mm) 10.1" (257 mm)
Environmental	Conforms to Mil Spec 810 for humidity, salt spray, temperature and UV. IP55 rated loudspeakers - IP56 rated connector cover.		

Note: See specification sheet for further details.

Transferable Warranty "(Limited)"

Distributed Design Series™ Surface Mount Loudspeakers are designed and backed by Community Professional Loudspeakers. For complete Community warranty information within the USA, please refer to the Warranty Card enclosed with the product. In other areas of the world please contact your local Community distributor.

Field Service Station:

Please call (610) 876-3400 for the nearest Authorized Field Service Station.

For Factory Service:

Please call (610) 876-3400 and obtain a Return Authorization (R/A) number before shipping any product to us.



Community Professional Loudspeakers
333 East Fifth Street, Chester, PA 19013-4511 USA
Phone: (610) 876-3400 • Fax: (610) 874-0190
www.communitypro.com

©2013 Community Professional Loudspeakers
All Rights Reserved.

v: 9MAY2013